

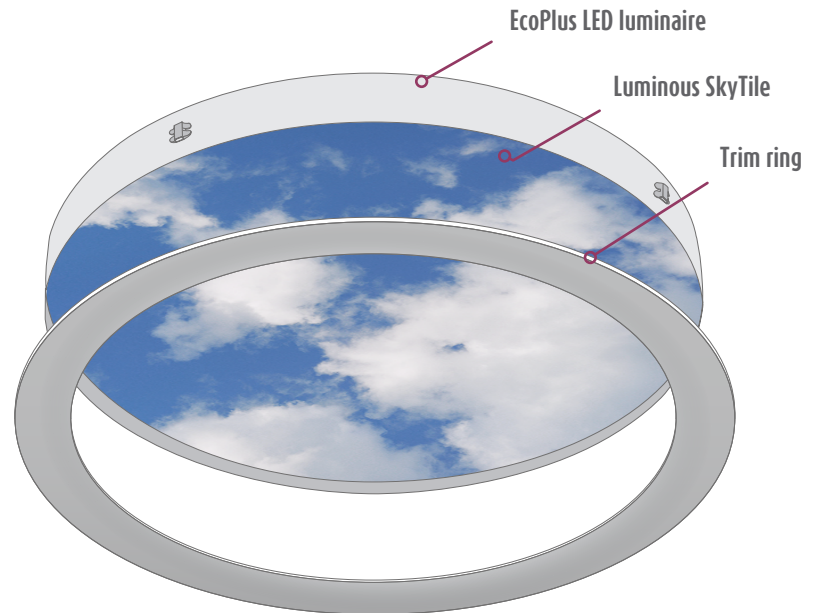

Aperture w/ EcoPlus Installation Instructions



Installation Packet Includes:

Aperture w/ EcoPlus Installation Instructions

Drop Ceiling and Hard Ceiling Cross-Sections included

One of three Custom EcoPlus Electrical Packets

Custom EcoPlus Electrical Packet (24PS HLG)

Custom EcoPlus Electrical Packet (HLG)

Custom EcoPlus Electrical Packet (Fixture Only)

Luminous SkyTile Installation

SkyTile Layout

Grid Plan GR1

Suspension Layout SP1

Electrical Layout EL1

Electrical Layout EL2

Grid Detail DE2-4

For technical support at any time during the installation, please call us **toll free at 866-759-3228**.

We want your installation to go as smoothly as possible. Thank you for choosing Sky Factory.

Table of Contents

Installation Requirements

Tools and Parts.....	2-4
Location Requirements.....	5
Suspension Requirements.....	6
Electrical Requirements.....	7
Fixture and SkyTile Orientation.....	7

Installation Instructions

Step 1: Create ceiling opening.....	8
Step 2: Plan for electrical.....	8
Step 3: Determine SkyTile orientation.....	9
Step 4: Attach suspension cables to building structure.....	9
Step 5: Lift fixture into position.....	9
Step 6: Secure fixture to suspension system.....	10

Step 7: Connect power.....	10
Step 8: Draw fixture up against grid or finished ceiling...	11
Step 9: Center fixture in opening.....	12
Step 10: Align trim and attach safety cables.....	12
Step 11: Engage panel clips.....	13
Step 12: To disengage panel clips (where required).....	13
Step 13: Trim joint alignment (5x8 only).....	14

Final Inspection List.....	15
-----------------------------------	-----------

Care and Maintenance.....	16
----------------------------------	-----------

Gripple Butterfly Trapeze Installation Guide.....	16
--	-----------

Appendix A: How to free stuck Gripple cables....	17
---	-----------

Grid Ceiling Cross Section.....	18
--	-----------

Hard Ceiling Cross Section.....	19
--	-----------

Installation Requirements

Tools and Parts

Tools Needed:

- Tools to attach suspension system to building structure
- Needlenose pliers, measuring tape, level and other hand tools
- Tools for installing electrical and running conduit (where required)

Parts Provided:

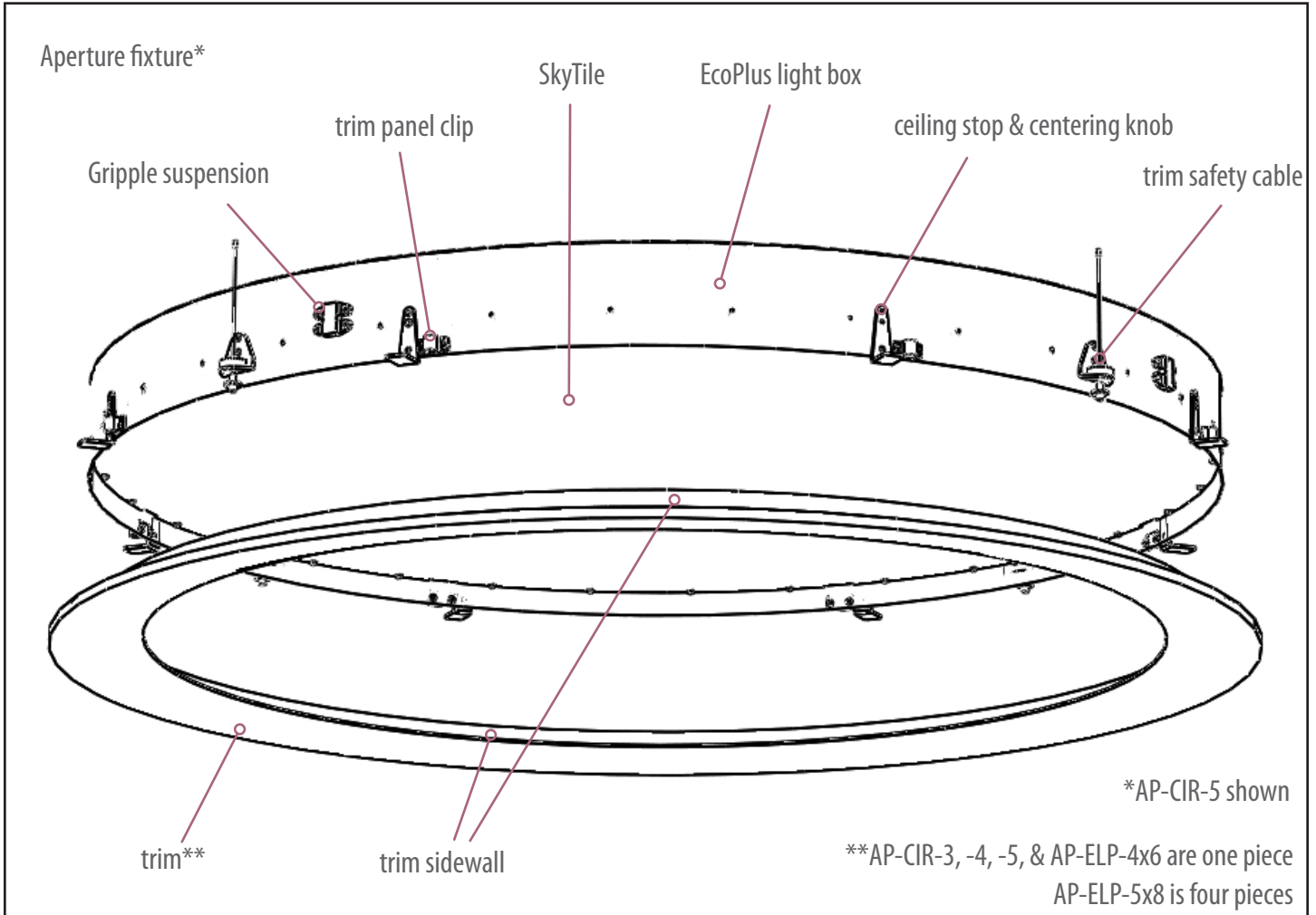

Sky Factory 24PS HLG Power System*

*optional MeanWell HLG or client-provided

Dimmer switch (optional)

*Lutron Diva DVSTV (North America) or Jung 240-10 (International)

Gripple suspension cable

loop type end

* 5' (1.5m) cable length

Gripple Butterfly Trapeze kit (backup only)*

x1 + x4

+ x4



* Gripple Butterfly Trapeze + 10-32 fastener + 1/4" spacer

Trim safety cable*

* 2 - 8 depending on model

Parts Needed:

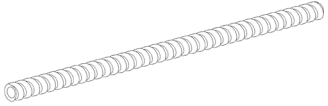
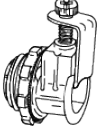
for AC Source power

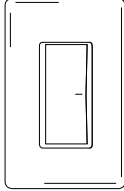
<p>Electrical wire</p> 	<p>Conduit * where required</p> 
	<p>1/2" trade size box connector* *as per application and code</p> 
<p>Standard 2x4 wall box and in-line switch where no dimmer is specified</p>  <p style="text-align: center;">+</p> 	

for DC power

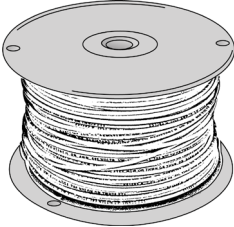
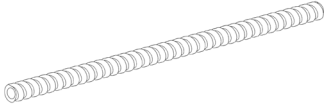
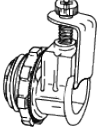
<p>Electrical wire</p> 	<p>Conduit * where required</p> 
	<p>1/2" trade size box connector* *as per application and code</p> 

Suspension

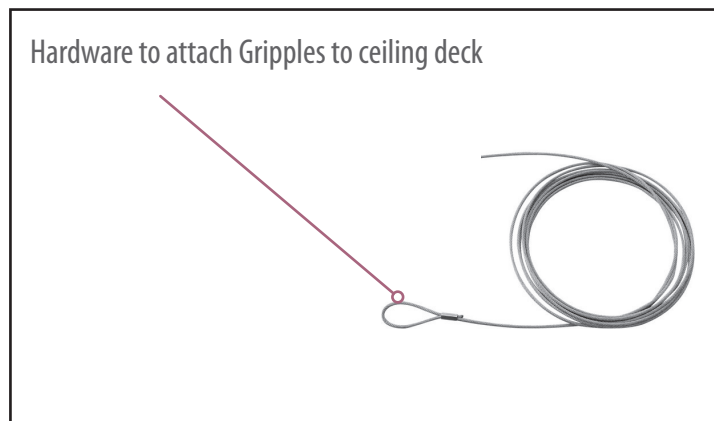

Location Requirements

Aperture SkyCeilings require selecting a location for the following components:

- SkyCeiling
- Dimmer or in-line power switch
- AC to DC power supply

SkyCeiling

- suspension anchor points must meet local and national codes
- must be dry and accessible for periodic cleaning
- can be installed in ceiling grid or imbedded in finished ceiling
- minimum space required above finished ceiling or grid: 6 7/8" (17.5cm)
not including means to connect suspension to building structure

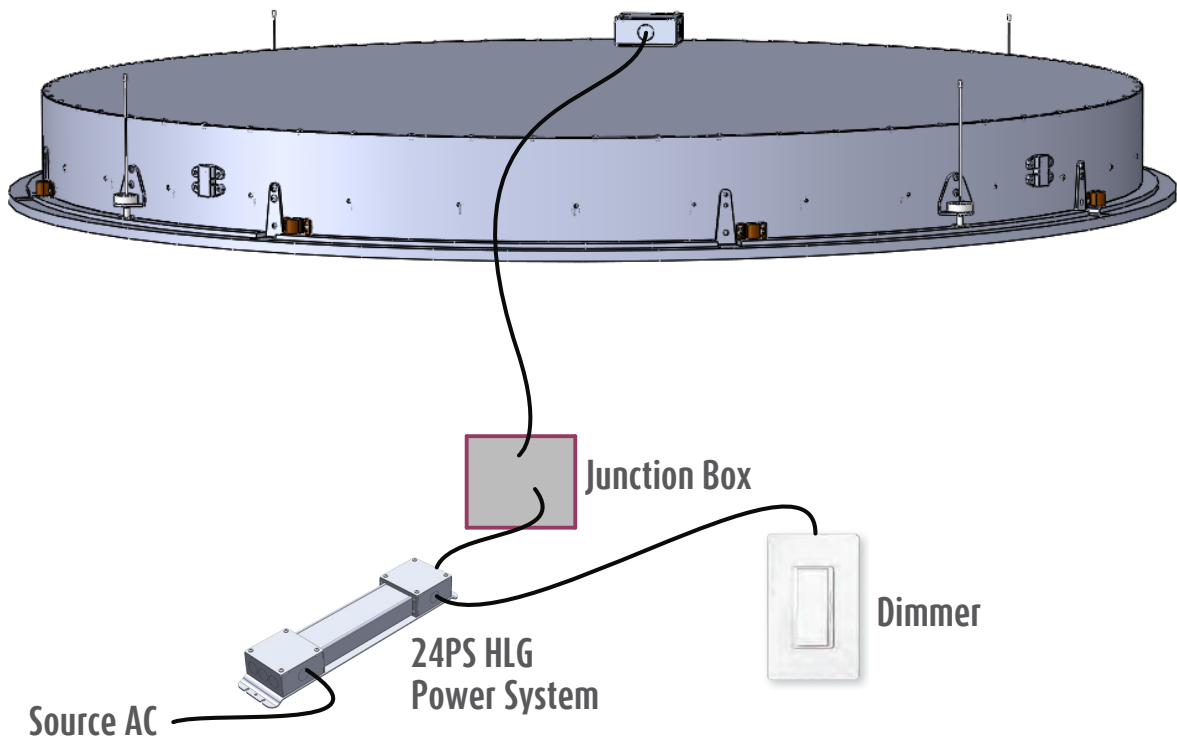

Power system

- must be dry, dust-free and accessible for periodic cleaning
- SkyFactory 24PS HLG shown

Dimmer

- wall box not provided
- Lutron Diva dimmer shown

Suspension Requirements

Fixture Suspension

Gripple Butterfly Trapeze suspension system (provided)

5' (152cm) stainless steel cable with loop end anchored to building structure

- Suspension anchor points not provided and must meet local and national codes

See drawing SP1 for suspension locations

Trim Suspension

Sugatsune suspension system (provided)

Panel clips secure trim to fixture

Safety cables with 5" reach help secure trim during installation and provide backup once trim is fully secured

SkyCeiling Dimensions and Weights

AP-CIR-3

7 3/8" (18.8cm) bottom of trim to top of fixture

32 1/2" (82.6cm) EcoPlus light box outside dia.

36" (92cm) trim outside dia.

23 lbs (10.5kg); 5.8 lbs (2.7kg) per suspension point

AP-CIR-4

7 3/8" (18.8cm) bottom of trim to top of fixture

44 1/2" (113cm) EcoPlus light box outside dia.

48" (122cm) trim outside dia.

40 lbs (18.2kg); 10 lbs (4.6kg) per suspension point

AP-CIR-5

7 3/8" (18.8cm) bottom of trim to top of fixture

56 1/2" (144cm) EcoPlus light box outside dia.

60" (153cm) trim outside dia.

63 lbs (28.6kg); 15.8 lbs (7.2kg) per suspension point

AP-ELP-4X6

7 3/8" (18.8cm) bottom of trim to top of fixture

44 1/2" x 68 1/2" (113cm x 174cm) EcoPlus light box outside dim.

48" x 72" (122cm x 183cm) trim outside dim.

62 lbs (28.2kg); 15.5 lbs (7.1kg) per suspension point

AP-ELP-5X8

7 3/8" (18.8cm) bottom of trim to top of fixture

56 1/2" x 92 1/2" (144cm x 235cm) EcoPlus light box outside dim.

60" x 96" (153cm x 244cm) trim outside dim.

101 lbs (45.9kg); 16.9 lbs (7.7kg) per suspension point

Electrical Requirements

At 120V AC:

AP-CIR-3 Series @ 0.3A, 37.4W

AP-CIR-4 Series @ 0.6A, 69W

AP-CIR-5 Series @ 0.9A, 112.1W

AP-ELP-4X6 Series @ 1.0A, 115.0W

AP-ELP-5X8 Series @ 1.6A, 195.5W

See one of three electrical packets:

Custom EcoPlus Electrical Packet (24PS HLG),

Custom EcoPlus Electrical Instructions (HLG), or

Custom EcoPlus Electrical Instructions (Fixture Only)

Electrical work must be performed by a qualified electrician who is familiar with DC lighting systems and must conform to all local and national codes.

Fixture and SkyTile Orientation

Fixtures **MUST** be installed so the SkyTile fits the SkyTile Layout.
SkyCeiling images are composed with a head/foot orientation.
See **SkyTile Layout** included.

Important:

Quick release label is for installation purposes only.

It orients the location and direction of tile in the ceiling.

Label **MUST** be removed once the SkyCeiling is fully installed and checked for proper orientation.

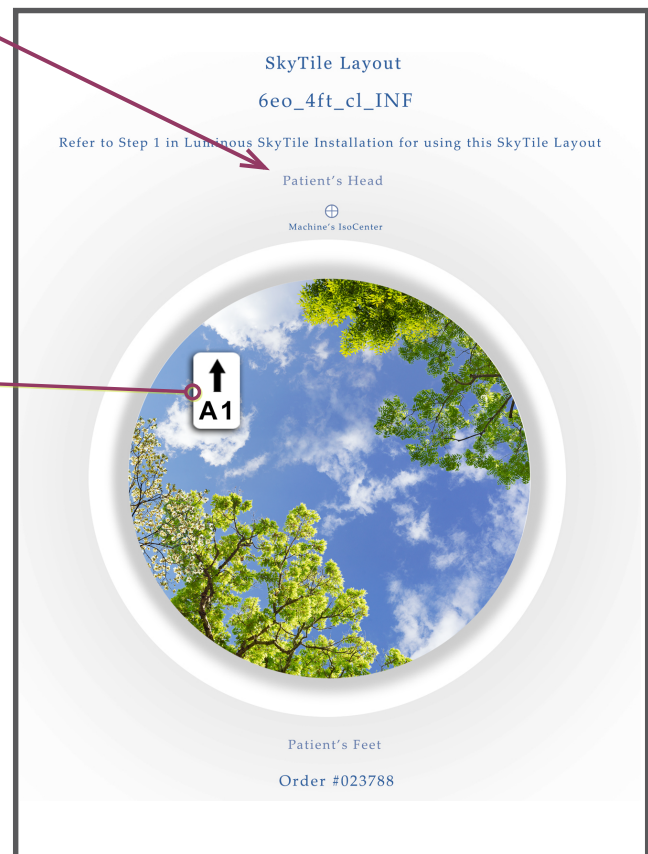

Installation Instructions

Step 1: Create ceiling opening

Frame opening or prepare grid in accordance with all local and national codes.

See also Suspension Requirements on page 6, cross sections on pages 18-19, and installation specific drawings GR1, SP1 and DE2-4 provided

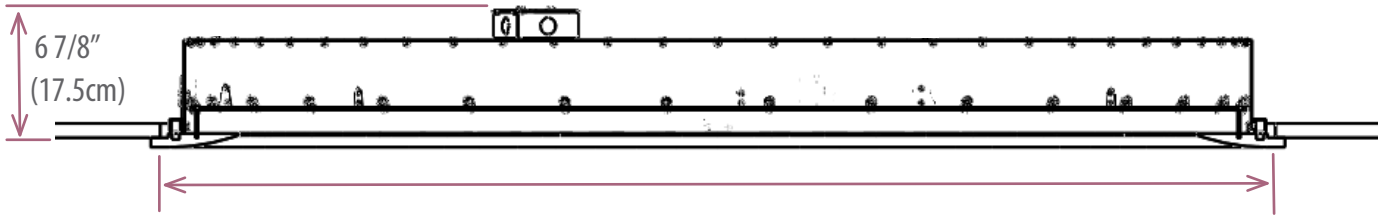

IMPORTANT: TRIM OVERLAP IS MINIMAL. OPENING MUST BE +/- 1/4" (0.64cm)

TEMPLATE PROVIDED FOR ELLIPSES

finished openings:

AP-CIR-3

35" (87.5cm) sidewall to sidewall or
15/16" grid on 3' center*

AP-CIR-4

47" (117.5cm) sidewall to sidewall or
15/16" grid on 4' center*

AP-CIR-5

59" (147.5cm) sidewall to sidewall or
15/16" grid on 5' center*

AP-ELP-4X6

47" x 71" (117.5cm x 177.5cm) sidewall to sidewall or
15/16" grid on 4' and 6' center*

AP-ELP-5X8

59" x 95" (147.5cm x 237.5cm) sidewall to sidewall or
15/16" grid on 5' and 8' center*

* Aperture series fixtures fit in standard imperial grid openings, but can be installed in a variety of off-center applications in both imperial and metric grid as well.

Step 2: Plan for electrical

See:

- **Location Requirements** on page 5
- **Step 7: Connect Power**
- **Custom EcoPluS Electrical Packet** provided

Step 3: Determine SkyTile orientation

- See page 7
- **IMPORTANT:** Be sure to orient the fixture following the **SkyTile Layout** sheet. If the SkyTile is improperly oriented, the fixture will have to be removed from the SkyCeiling and re-installed in the proper orientation.

Step 4: Attach suspension cables to building structure

See:

- **SP1** for SkyCeiling suspension points
- "Suspension Requirements" on page 6 for SkyCeiling weights

Attach cables to building structure following all local and national codes

Ensure cables extend at least 3" (8cm) below Gripper when fully installed.

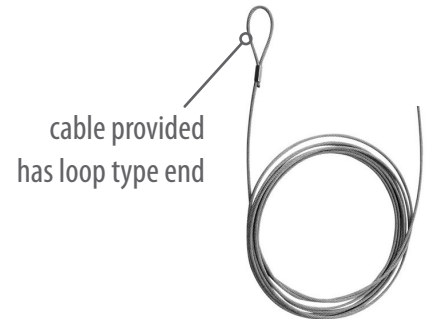

Step 5: Lift fixture into position

IMPORTANT: Lift fixture by sidewall or ceiling stops. **DO NOT LIFT AGAINST SKYTILE.**

Do not overflex fixture when positioning. Too much flexion could crack SkyTile.

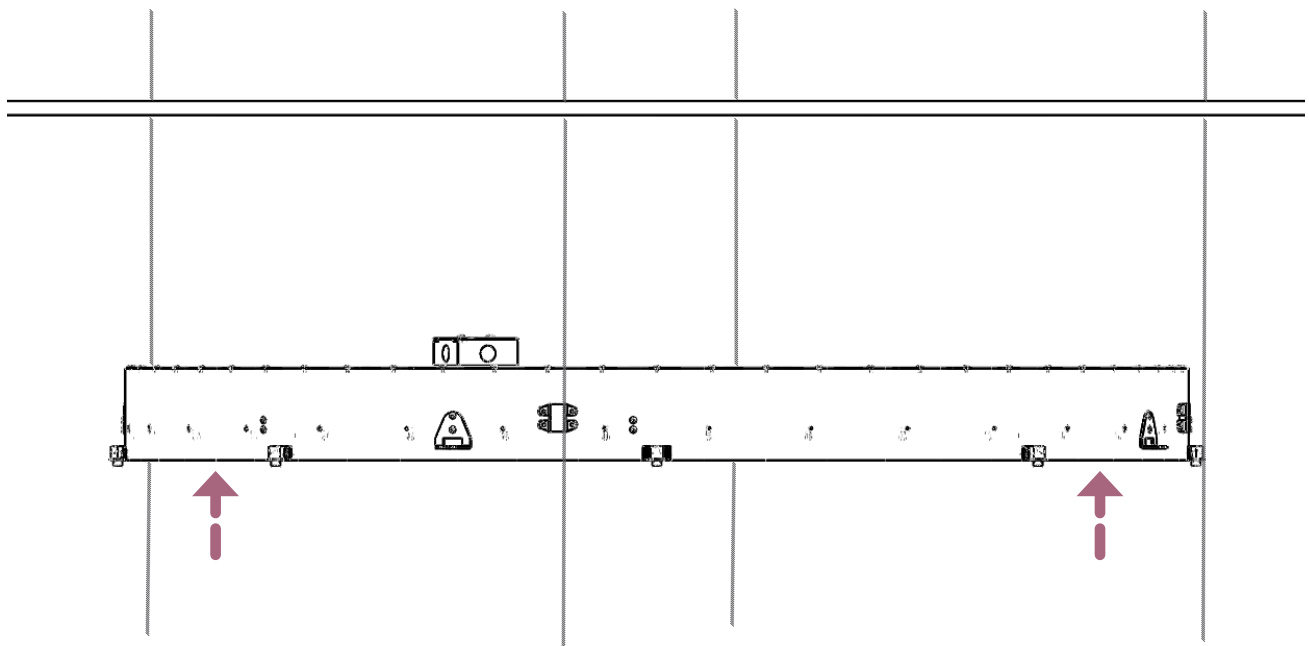

Step 6: Secure fixture to suspension cables

Operating the **Gripple Butterfly Trapeze** suspension system

- See also Gripple installation sheet on page 16.

To adjust load upward:

Thread cable down through Gripple, then lift fixture and pull on tail

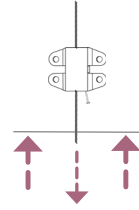

To adjust load downward:

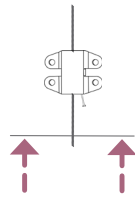

Lift up on fixture to remove load

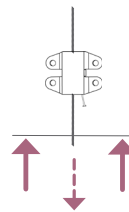

Pull on cable tail to release internal wedge

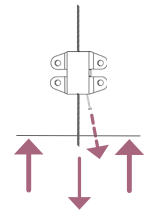

Pull down on pin to free cable

IMPORTANT: DO NOT FORCE PIN

Gripple safety mechanism – release pin will break loose if forcefully pulled under load.

If cable is wedged too tight and won't release, see Appendix A: How to Free Stuck Gripple Cables

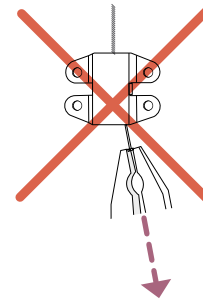

Step 7: Connect power

See **Custom EcoPlus Electrical Packet** provided for wiring details

- Must conform to all local and national codes
- Test electrical before Step 8

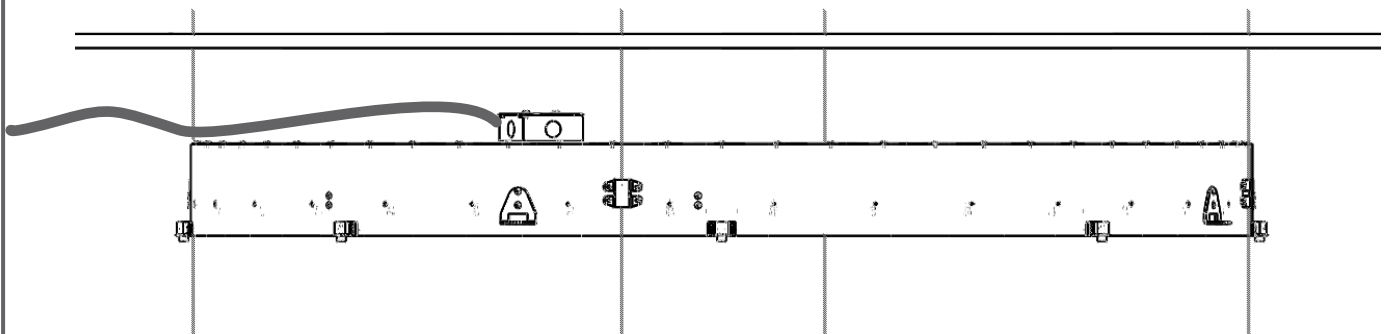

Step 8: Draw fixture up against grid or finished ceiling

Do not overflex fixture when snugging up cables. Work from Gripple to Gripple lifting fixture 3-4" (7-10cm) at a time

NOTE: Install trim safety cables before seating fixture against finished ceiling. Cables will hang from bracket, and push up once attached to trim.

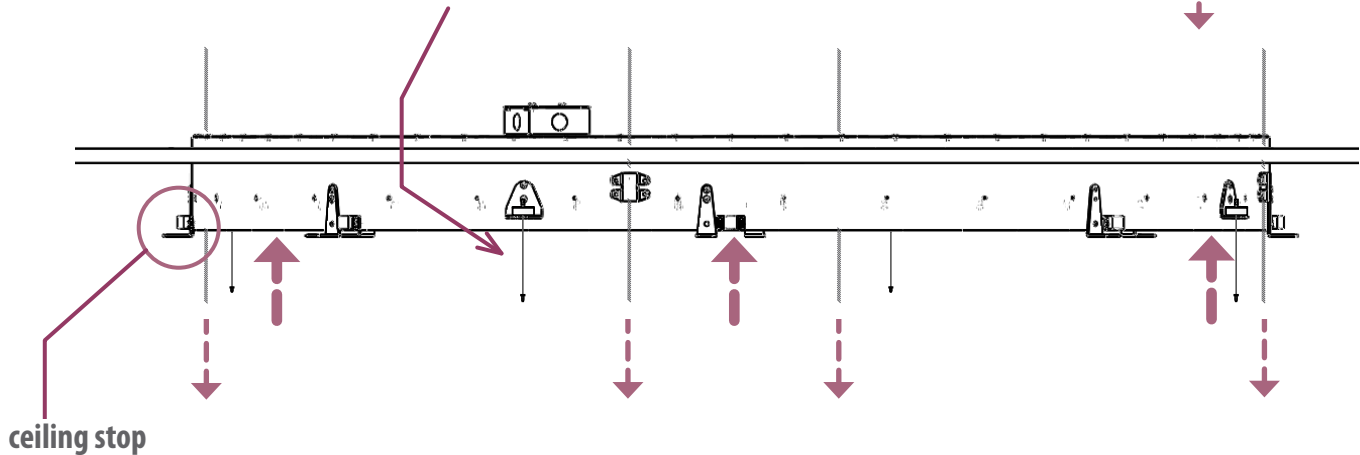
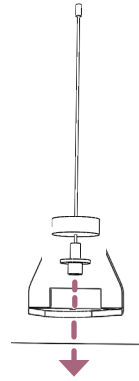

ceiling stop

- sets height of fixture in relation to bottom of grid or finished ceiling so trim will seat properly
- in finished ceiling applications only, stops fixture from lifting when trim is snapped into place. See SP1 and GR1.

IMPORTANT: Stop needs to be snug only against ceiling.

If Gripple is pulled too tight, it can be hard to release. See Step 6 and Appendix A.

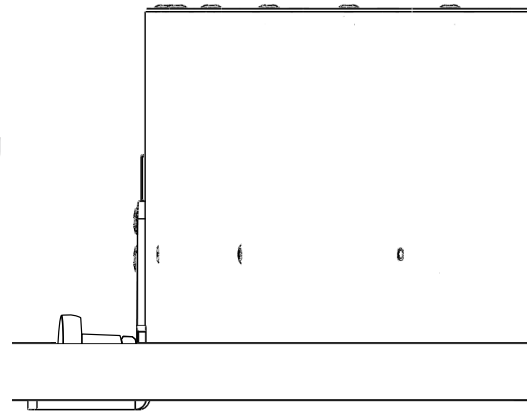

IMPORTANT: Bottom edge of fixture must sit in same plane for trim to secure properly.

Once fixture is firmly seated against ceiling or grid,
stow loose suspension cables out of the way above the ceiling

DO NOT CUT CABLES! LEAVE FOR FUTURE MAINTENANCE, IF NEEDED!

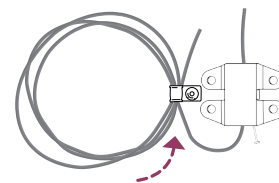

Step 9: Center fixture in opening

adjust knobs on ceiling stops to center fixture.

in ceiling grid applications, knob may ride against grid
or against cut acoustical tiles

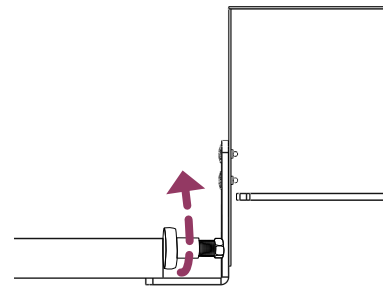

Step 10: Align trim with fixture sidewall and attach safety cables

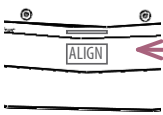
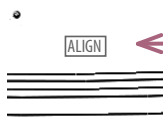

line up label on fixture sidewall
with label on trim

(AP-CIR-3,-4,-5 only)

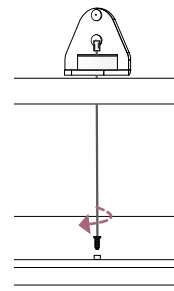

thread end of safety cable
into nut inserted
on top of trim

IMPORTANT:

APERTURE TRIM IS A TRIM SYSTEM ONLY:

- **SAFETY CABLES (STEP 10) AND PANEL CLIPS (STEPS 11-12) ARE DESIGNED TO SUPPORT WEIGHT OF TRIM ONLY!**
- **DO NOT HANG OR SET ANY ADDITIONAL COMPONENTS, INCLUDING INSTALLATION TOOLS AND CEILING GRID, ON TRIM DURING OR AFTER INSTALLATION!**
- **WHEN SEATING TRIM, MAKE SURE PANEL CLIPS ARE FULLY ENGAGED!**

Step 11: Engage panel clips

NOTE: Make sure all suspension cables are stowed out of the way
Make sure fixture sits in a single plane. If panel clips do not fully engage, fixture height may need adjusted.

AP-CIR-3, -4, -5, & AP-ELP-4x6 are one piece
AP-ELP-5x8 is four pieces –
for 5x8 trim alignment, see Step 12

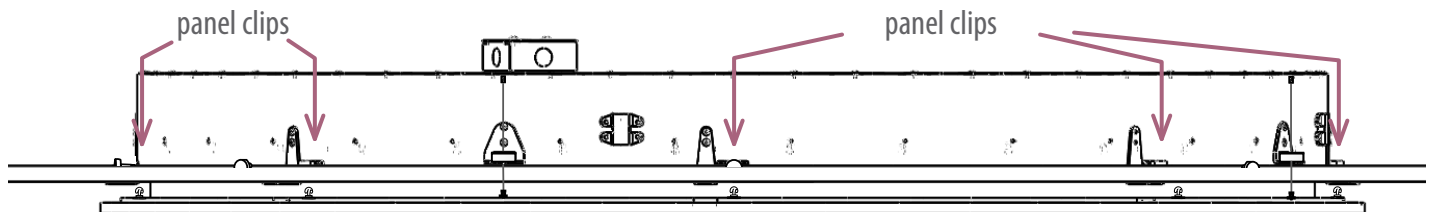

IMPORTANT: In ceiling grid applications, fixture must be manually held when engaging or disengaging clips

to engage clips:

- line up male clip on trim to female clip on fixture
- push up firmly on trim **RIGHT BELOW CLIP**

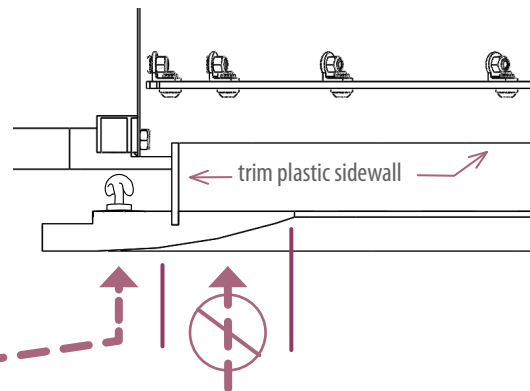

IMPORTANT:
DO NOT PUSH UP ON TRIM
WITHIN 2 1/2" FROM INSIDE EDGE

NOTE: Grid applications may require final height adjustment after trim is installed

Step 12: To disengage panel clips (where required)

to disengage clips:

- gently but firmly pull down on trim in clip location

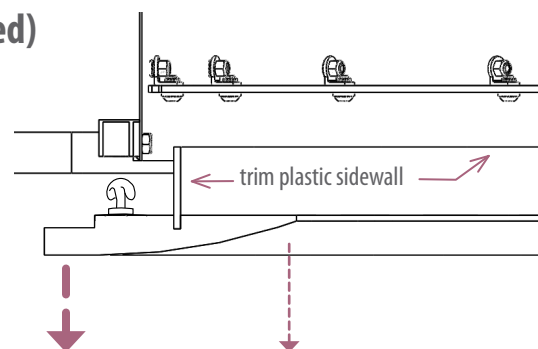

IMPORTANT:
PULL DOWN AS MUCH AS POSSIBLE
ON OUTSIDE OF TRIM

Step 13: Trim joint alignment (5x8 only)

Alignment clips sit on inside ledge of trim and lock together

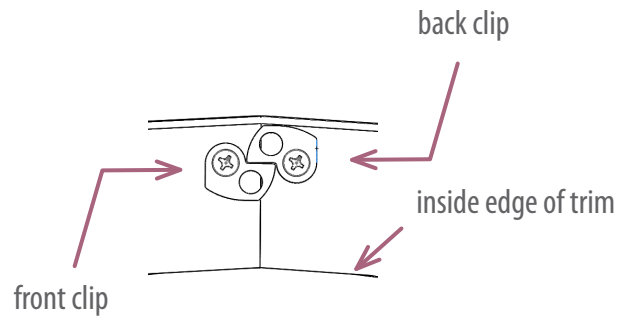

Pinch joint so two sides line up horizontally

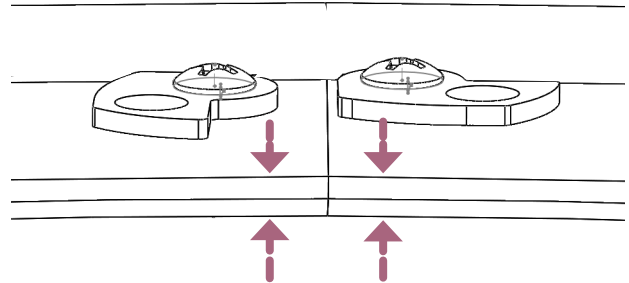

Rotate back clip into position – straight leg should be perpendicular to joint

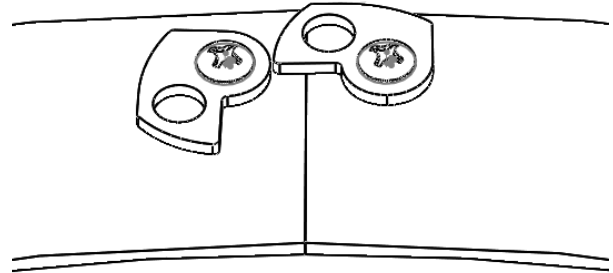

Then rotate front clip into position – straight leg should be perpendicular to joint

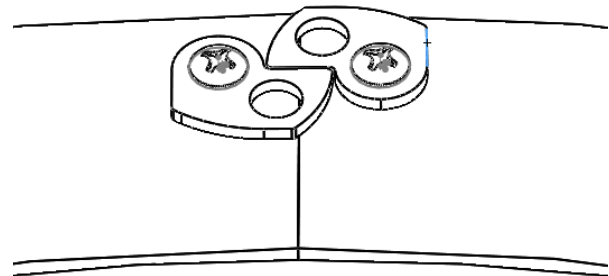

Final Inspection List

Is the trim seated up against the grid flange or finished ceiling?

- If not, make sure all panel clips are fully engaged.
- Height of fixture in relation to finished ceiling or grid may need to be adjusted.

If Ap-Elp-5x8, have trim joint alignment clips been adjusted?

- If not, make sure all alignment clips are engaged and trim lines up at joints.

In grid ceiling applications, does the fixture sit evenly in the grid?

- If not, fixture alignment may need adjusting.
- If grid is not installed square, fixture may sit unevenly in the opening. If so, adjust grid so it is square.

Is the image evenly lit?

- If not, contact Sky Factory.

Does the SkyCeiling image match the SkyTile Layout image?

- If the SkyTile Layout has a head location, make sure the SkyCeiling is properly oriented in the room. If not, it should be reinstalled.

Has the arrow-label been removed once the image has been verified? If not, remove it now.

- Quick release label **MUST** be removed once the SkyTile is fully installed and checked for proper orientation.

Care and Maintenance

- Avoid scratching SkyTile and Trim when cleaning.
- Once installed, SkyTile and Trim can be cleaned in place.
- Use a mild soap and water solution, and a soft, damp-only, non-abrasive cloth.
- **DO NOT** wet edges of SkyTile. Water may cause image film to de-laminate.

Butterfly Trapeze Hanger



Cable hanger with one-way fastener or the fast suspension of rectangular duct and similar equipment in an indoor stationary setting. NOT suitable for use in chlorinated / swimming pool environments.

FEATURES / BENEFITS

- Attaches to side of duct with self-drilling screws (not provided)
- Rubber pad prevents air leakage and dampens vibration
- Simple height adjustment using the built-in release pin prior to applying load
- Conforms to DW144 Class D
- Ideal for rectangular duct suspended close to the ceiling; can also be used for multi-tiered installations
- Supplied as a ready-to-use kit comprising a length of cable with pre-attached end fixing



INSTALLATION & ADJUSTMENT

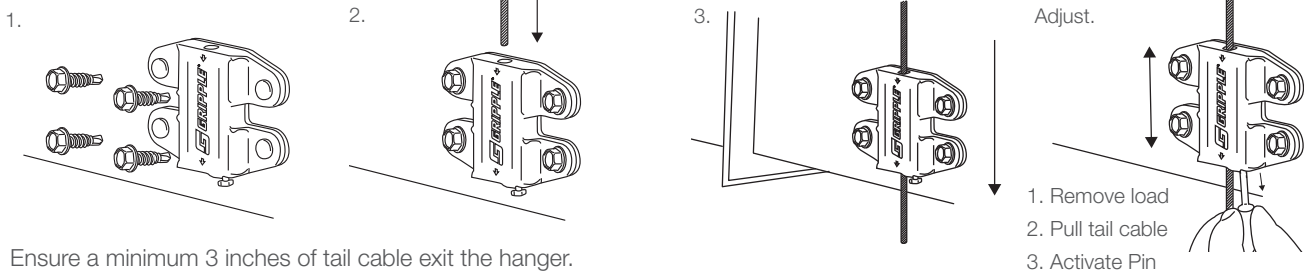

SIZE SPECS

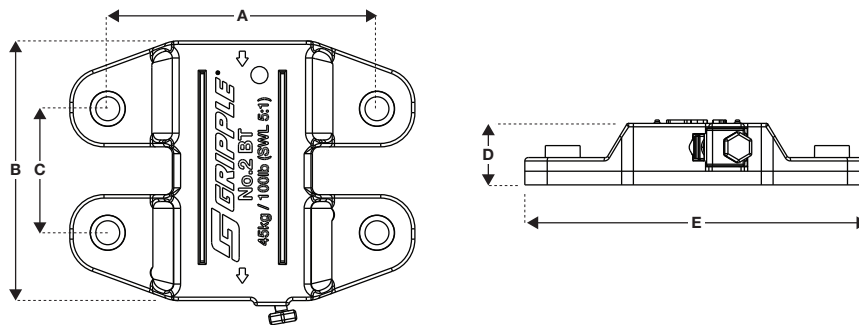

Dimension	(inches)
A	1.54
B	1.50
C	0.71

Dimension	(inches)
D	0.35
E	2.00

AVAILABLE END FIXINGS



For more options on available end fixings please contact us or visit www.gripplE.com

CABLE SPECS

Galvanized high tensile steel cable to EN12385. Standard lengths from 5ft-30ft, other lengths can be made to order.

	No.2
Cable Diameter	5/64"
Strand Configuration	7x7
Min. Breaking Load	500 lbs
Max. Safe Working Load	100 lbs
Tensile Strength (lbs/sq.in.)	256,700

FASTENER SPECS

Housing - Type ZA2 Zinc

Wedge - Sintered steel hardened to min. 56 Rockwell C

Spring - Stainless Steel (Type 302)

End Cap - UV stabilized homopolymer propylene

Rubber Pad - EPDM 40±5 SHORE A

Pin - A2 Stainless Steel

Safe Working Load:

No.2 - up to 100 lbs @5:1 safety factor

PI-BTRAPEZE-US

www.gripplE.com

GripplE's policy is one of continuous development and innovation. We therefore reserve the right to alter specifications, etc. without notice.



GripplE Inc | 1611 Emily Lane | Aurora, IL 60502 | USA

Tel +1 866 474 7753 Fax +1 800 654 0689 Email gripplEinc@gripplE.com

Appendix A: How to Free Stuck Gripple Cables

If cable is wedged too tightly and won't release::

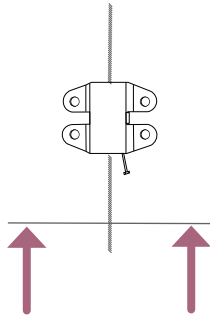

Step 1:
Support fixture
so cable is not carrying load

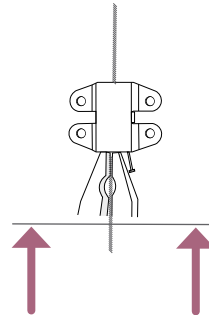

Step 2:
Grip cable with pliers
against bottom of Gripple

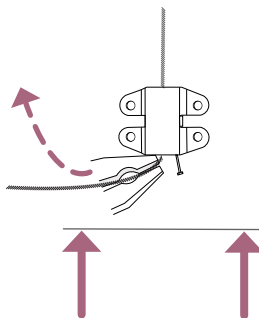

Step 3:
Gently roll cable sideways
while wedging pliers against Gripple

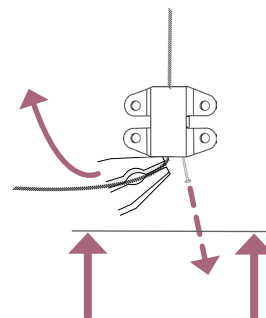

Step 4:
When cable is loosened
pull down on pin

**NOTE: If a Gripple is damaged beyond repair,
an extra Gripple with stand-offs and machine screws is included**

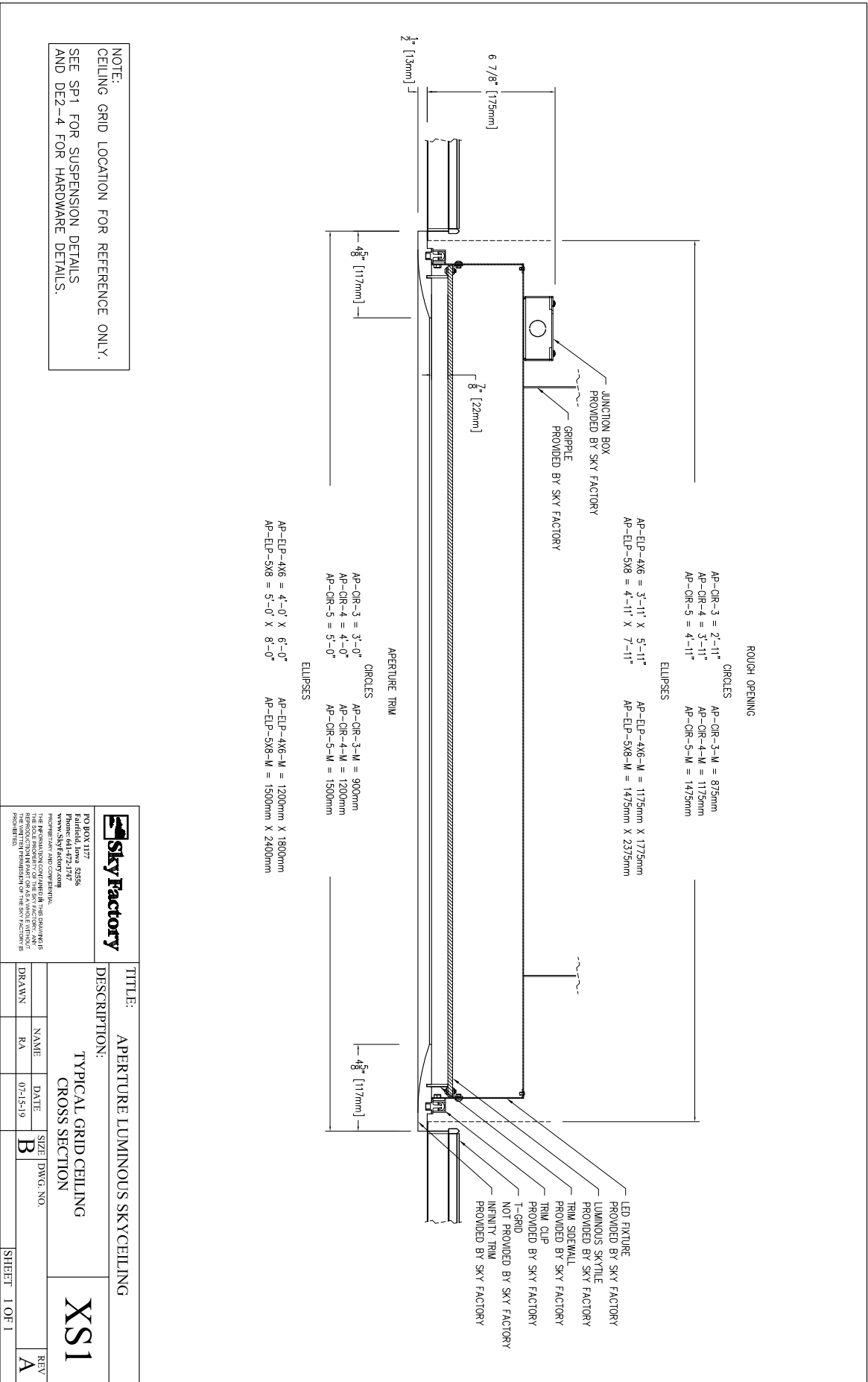

NOTE:
CEILING GRID LOCATION FOR REFERENCE ONLY.
SEE SP1 FOR SUSPENSION DETAILS
AND DE2-4 FOR HARDWARE DETAILS.

		PO BOX 117 Fairfield, Iowa 52506 Phone: 641-252-7478 Fax: 641-252-7478 www.skyfactory.com INFORMATION AND COMMENTS: THE INFORMATION CONTAINED IN THIS DRAWING IS REPRESENTATIVE OF THE SKY FACTORY'S REPRODUCTION CAPABILITY AND IS NOT TO BE REPRODUCED OR TRANSMITTED IN ANY FORM OR BY ANY MEANS, ELECTRONIC OR MECHANICAL, INCLUDING PHOTOCOPYING, RECORDING, OR BY ANY INFORMATION STORAGE AND RETRIEVAL SYSTEMS, WITHOUT THE WRITTEN PERMISSION OF THE SKY FACTORY.	
		TITLE: APERTURE LUMINOUS SKYCEILING DESCRIPTION: TYPICAL GRID CEILING CROSS SECTION	
DRAWN	NAME	DATE	SIZE
RA	RA	07/15/19	B
DWG. NO.			REV
SHEET 1 OF 1			A

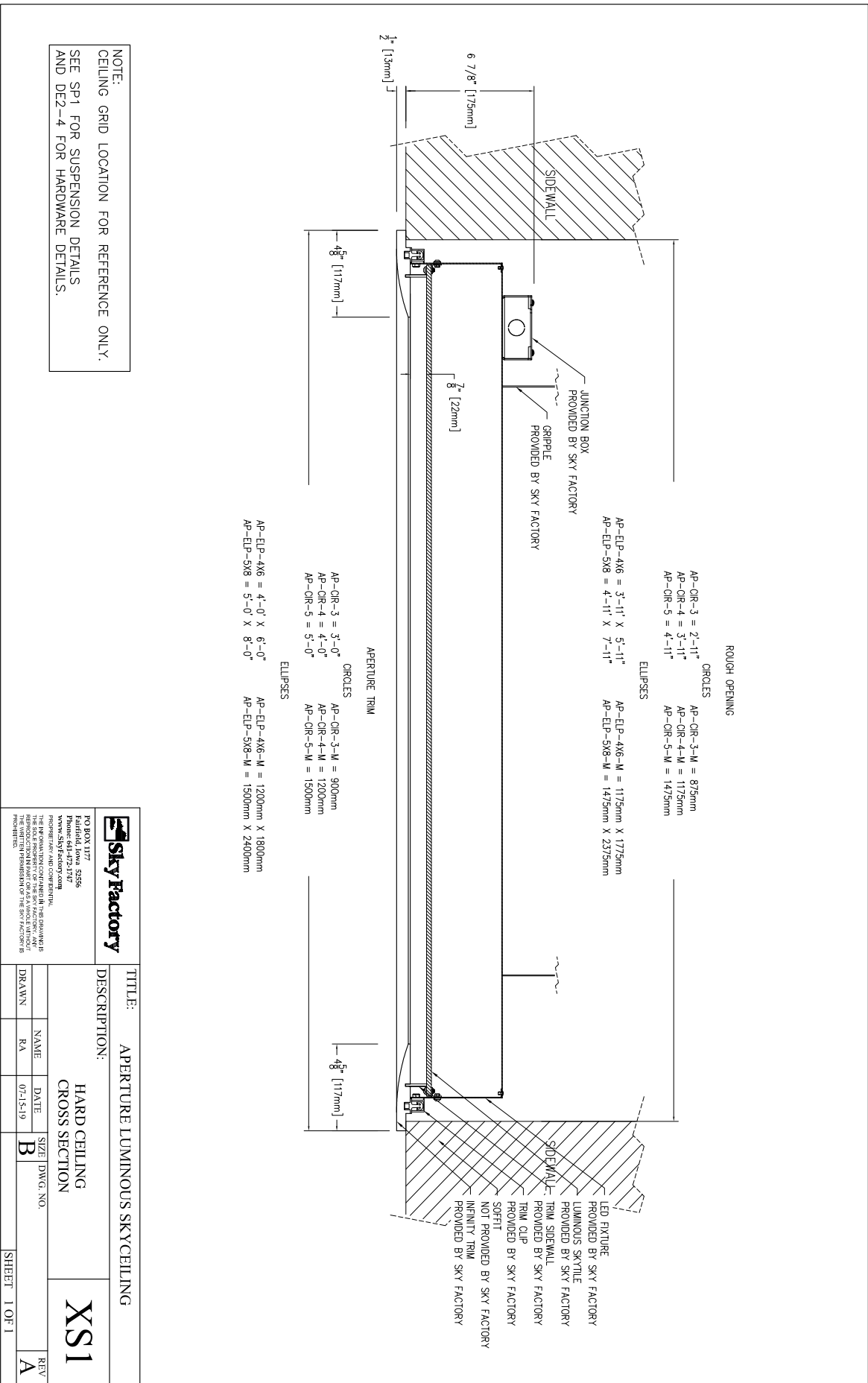

NOTE:
 CEILING GRID LOCATION FOR REFERENCE ONLY.
 SEE SP1 FOR SUSPENSION DETAILS
 AND DE2-4 FOR HARDWARE DETAILS.

		PO BOX 117 Fairfield Iowa 52525 563-379-2222 www.skyfactory.com PROPRIETARY AND CONFIDENTIAL	
THE INFORMATION CONTAINED IN THE DRAWING IS THE PROPERTY OF SKY FACTORY. IT IS TO BE USED FOR THE PROJECT AND SITE SPECIFICALLY IDENTIFIED HEREIN ONLY. WITHOUT THE WRITTEN PERMISSION OF SKY FACTORY, NO PART OF THIS DRAWING IS TO BE REPRODUCED OR TRANSMITTED IN ANY FORM OR BY ANY MEANS, ELECTRONIC OR MECHANICAL, INCLUDING PHOTOCOPYING, RECORDING, OR BY ANY INFORMATION STORAGE AND RETRIEVAL SYSTEM.			
TITLE: APERTURE LUMINOUS SKYCEILING		DESCRIPTION: HARD CEILING CROSS SECTION	
DRAWN: RA	NAME: RA	DATE: 07-15-19	SIZE: B DWG. NO.:
SHEET 1 OF 1			REV: A